

A-A

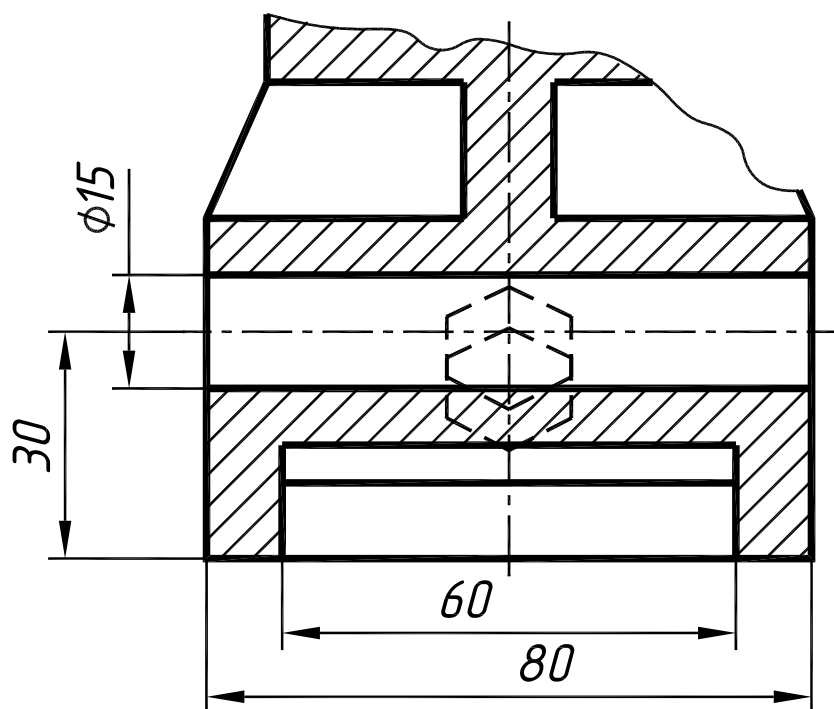

B-B

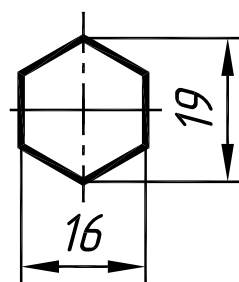

270

