

Задание №1 «Плоский контур»
Вариант №3

1

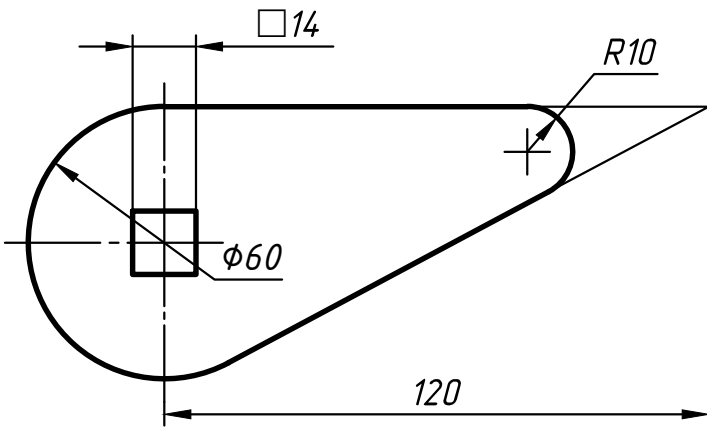

2

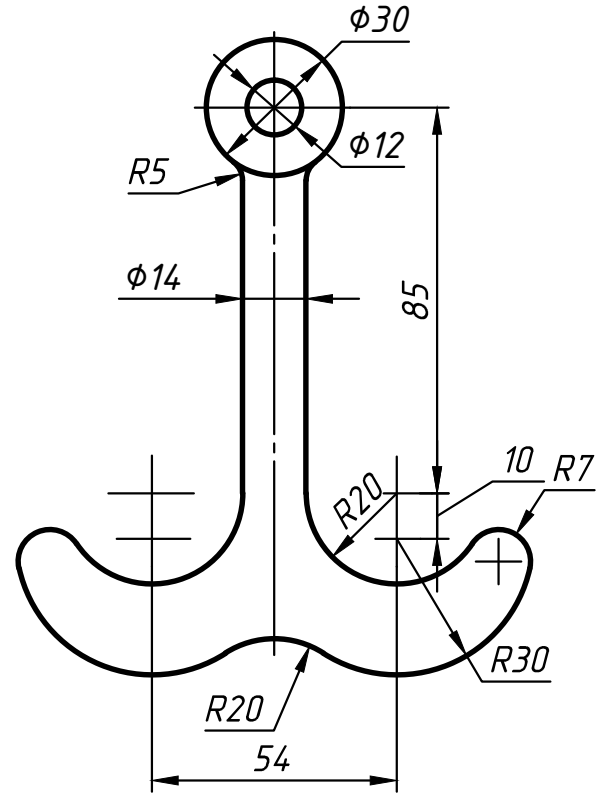

3

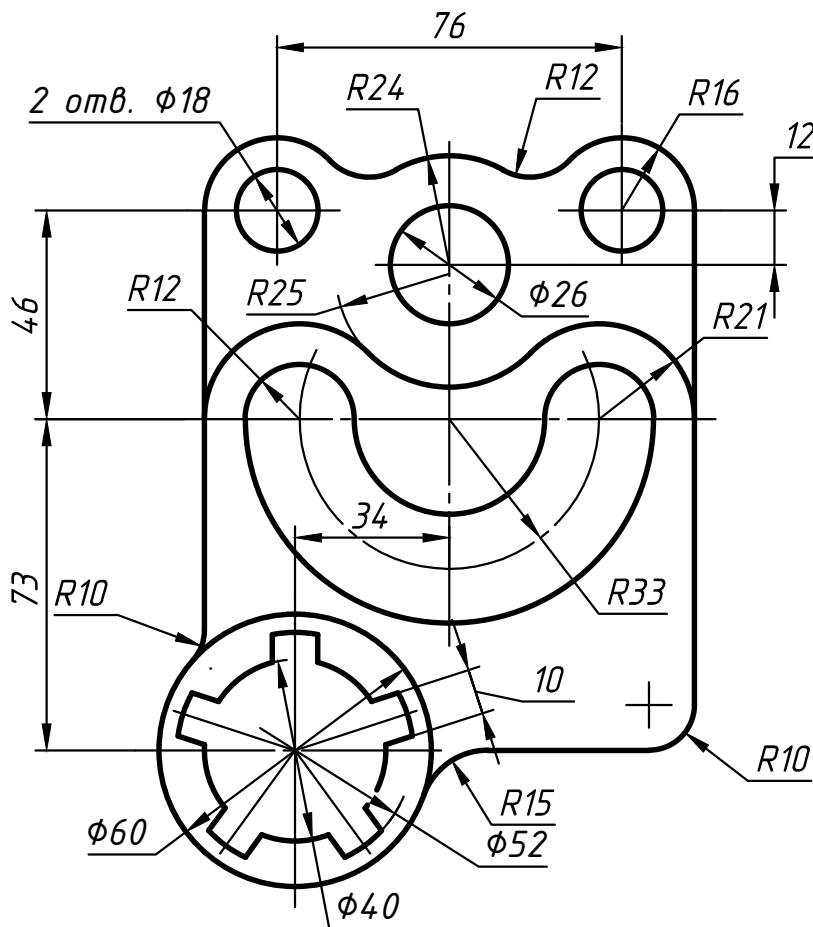

4

