

Задание №1 «Плоский контур»  
Вариант №28

1

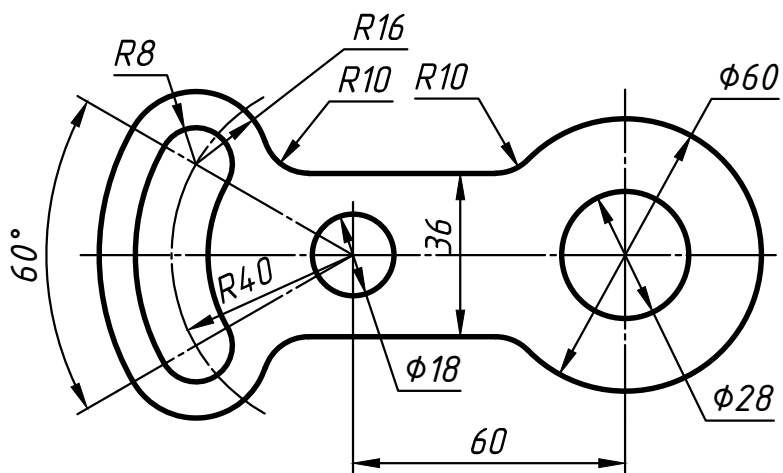

2

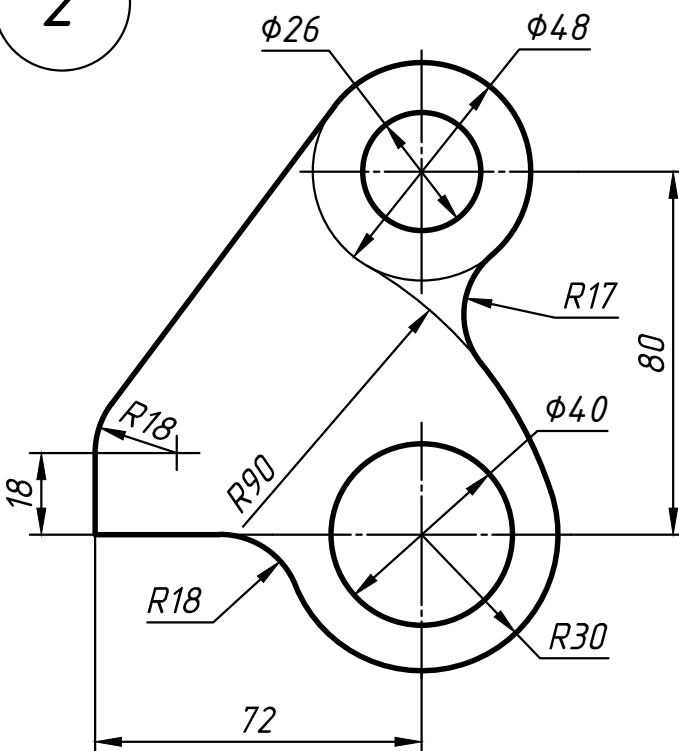

3

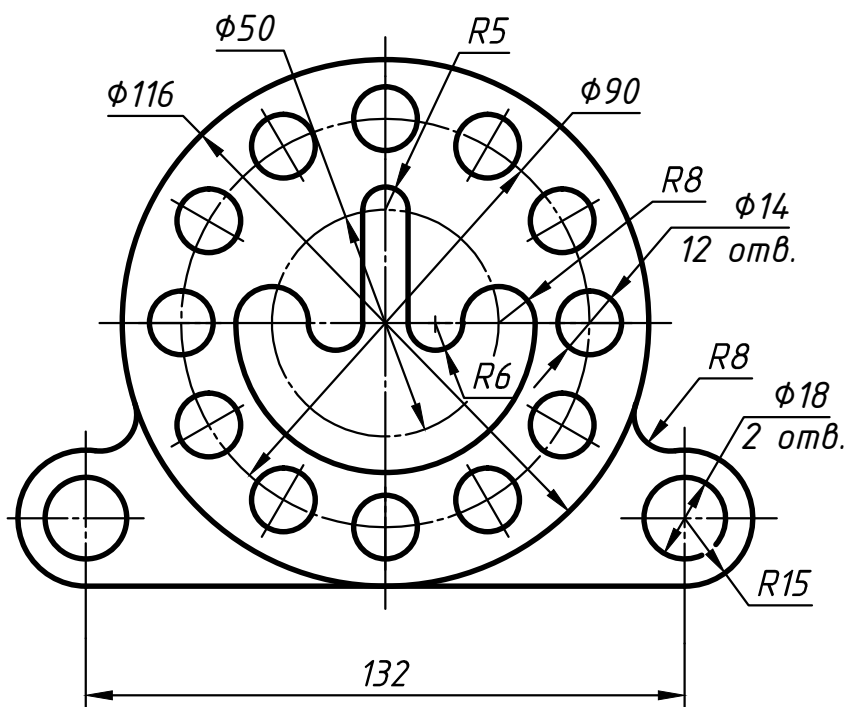

4

