

Задание №1 «Плоский контур» Вариант №25

1

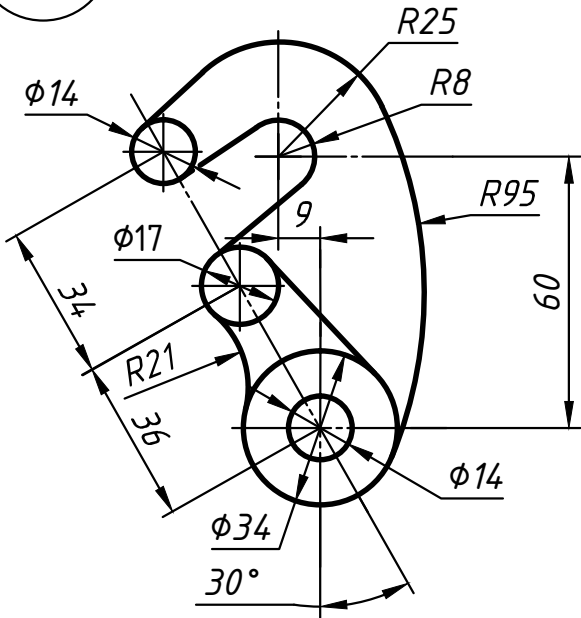

2

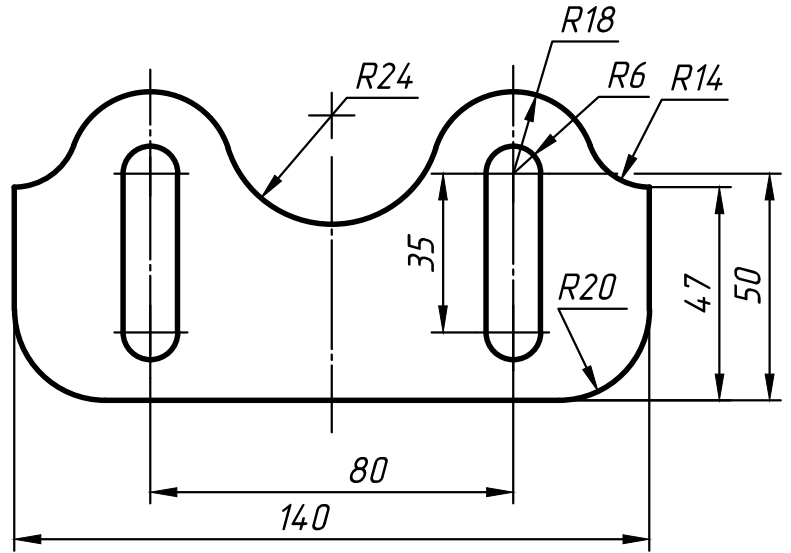

3

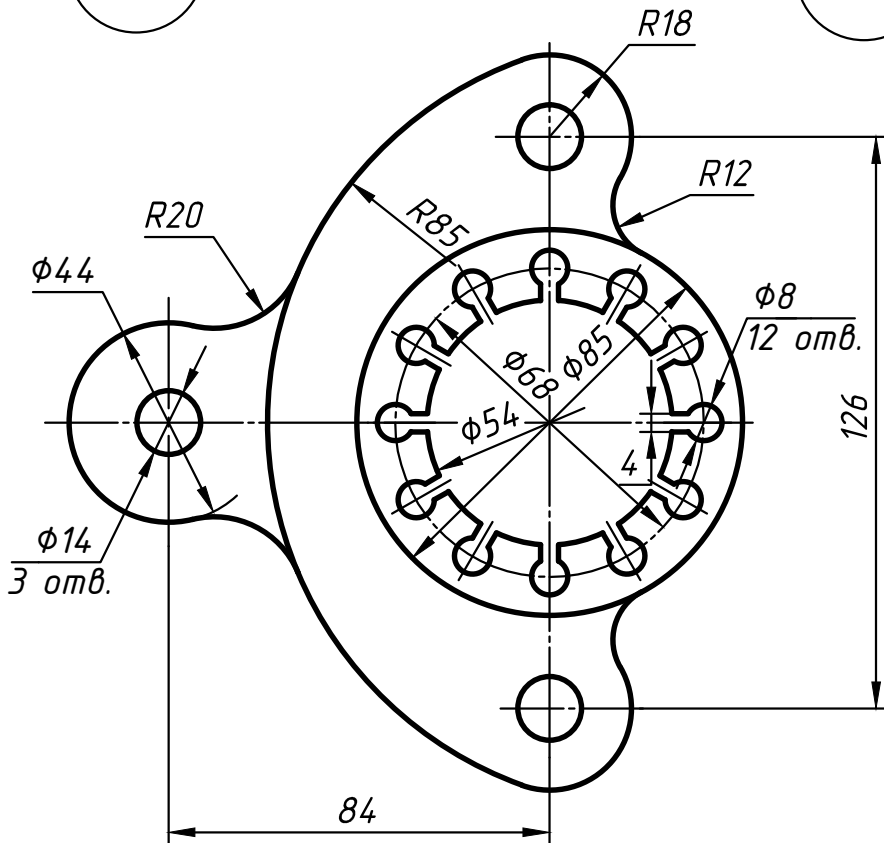

4

