

Задание №1 «Плоский контур»  
Вариант №23

1

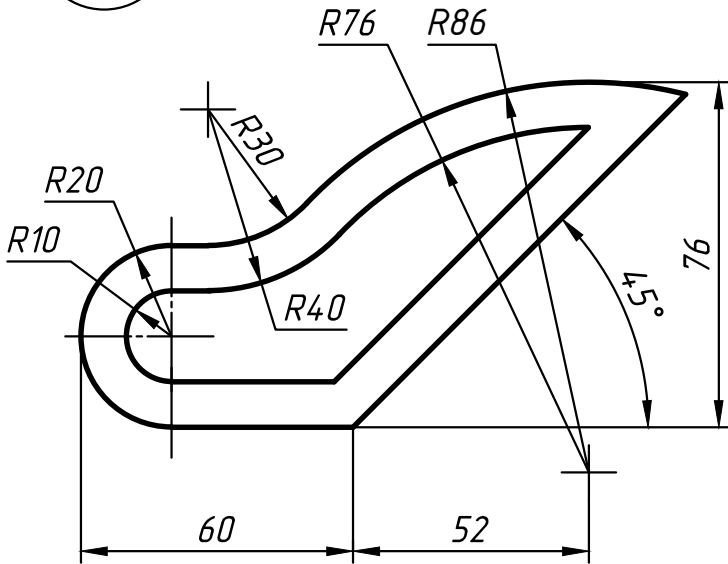

2

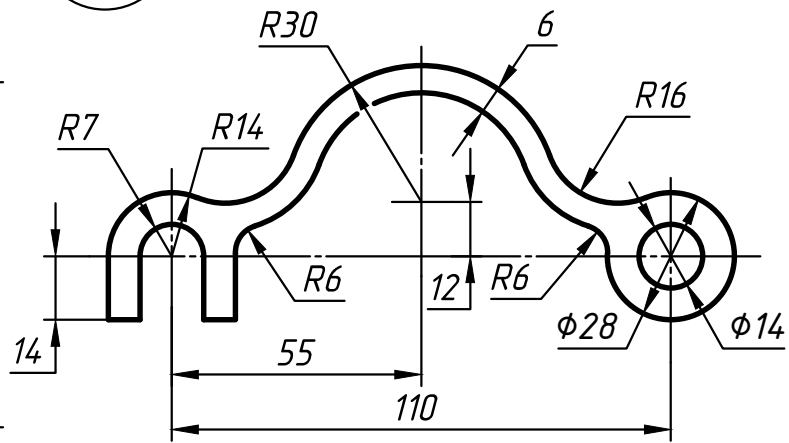

3

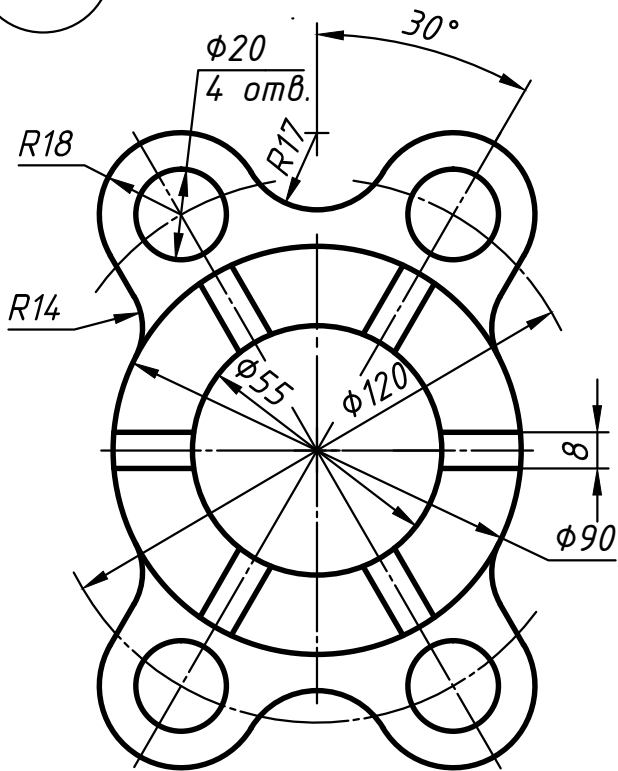

4

